

Description

1. Technical Specifications	1
2. Identification Data	3
3. Location of Parts	4
4. Steering cum Ignition lock	5
5. Fuel Tank Cap / Fuel Tap	6
6. Speedometer Details	7
7. Speedometer Setting	9
8. Control Switches	11
9. Front / Rear seat	13
10. Fitment of Front & Rear Seat	14
11. Daily Safety Checks	15
12. How to ride your Bike	16
13. Safe Riding Tips	20
14. Engine Oil	21
15. Wheels - Tube less Tyre	22
16. Battery	23
17. Periodic Maintenance Information	24
18. Brake Fluid	26
19. Periodic Maintenance & Lubrication Chart	27
20. Non Use Maintenance	

Safety and Warning information :



Warning : This indicates that a potential hazard or injury to you or other persons & to the vehicle can happen, if advice provided is not followed.



Caution : This indicates that a potential hazard which could result in vehicle damage, if advice provided is not followed.

Notice:

The description and illustration in this booklet are not to be taken as binding on the manufacturers. The essential features of the type described and illustrated herein remaining unaltered. Bajaj Auto Limited reserves the right to carry out at any moment without being obliged to bring this booklet upto-date & to do modifications on the vehicle, parts or accessories as may be convenient and necessary.

Engine	: 4 Stroke, Single Cyl.
Bore x Stroke	: 58.0 mm x 60.7 mm
Engine Displacement	: 160.3 cc
Compression Ratio	: 9.8 \pm 0.5 : 1
Idling Speed	: 1400 \pm 100 RPM
Max. Net Power	: 15.5 PS at 8500 RPM
Max. Net Torque	: 14.6 Nm at 6500 RPM
Ignition System	: DC
Spark Plug	: 2 Nos
Spark Plug Gap	: 0.7 ~ 0.8 mm
Transmission	: 5 speed constant mesh
Gear Shifting Pattern	: 1 Down 4 Up
Engine Lubrication	: Forced Lubrication
Starting Aid	: Self Start / Kick start
Front Brake	: Petal Disc type
Rear Brake	: Drum type

Fuel Tank Capacity	
Full	: 12 liters
Usable Reserve	: 2.4 liters
Unusable Reserve	: 0.2 liters
Dimensions	
Length	: 2012 mm
Width	: 803.5 mm
Height	: 1060 mm
Wheel base	: 1363 mm
Ground clearance	: 176 mm
Tyre Size	
Front	: 80/100-17,46P tubeless
Rear	: 110/80-17,57P tubeless
Tyre Pressure	
Front	: 1.75 kgf/cm ² (25 PSI)
Rear (Solo)	: 1.93 kgf/cm ² (28 PSI)
Rear (with pillion)	: 2.25 kgf/cm ² (32 PSI)

Electrical System	: 12 Volts DC
Head Lamp	: 55/60 W, (Halogen)
Position Lamp	: 3W (2 nos.)
Tail /Stop Lamp	: LED type
Side Indicator lamp	: 10W (4 nos.)
Neutral Indicator	: Green LED
Hi Beam Indicator	: Blue LED
Turn Signal Indicator	: Green LED
Side Stand Indicator	: LCD
Speedometer Lamp	: LCD
Low Battery Indicator	: Red LED
Low Oil Pressure	: Red LED
Service Reminder	: LCD
Bajaj Logo	: Blue LED
Rear No. Plate Lamp	: 3W
Horn	: 12V DC, Type 2A (82mm dia.)
Battery	: 12V - 4 Ah VRLA

Vehicle Kerb Weight : 142 kg.

Gross Vehicle Weight : 217 kg.

(Vehicle kerb weight together with rider 75kg)

Max. Speed : 107 Kmph

Note :

- **All dimensions are under UNLADEN condition.**
- **Above information is subject to change without any notice.**

The Frame and Engine serial numbers are used to register the motorcycle. They are the unique alpha-numeric codes to identify your particular vehicle from others of the same model and type.

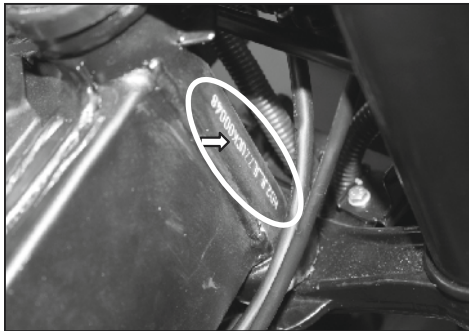

Frame Number Location

- ★ On RH Side of Steering Tube
(Alpha-Numeric - 17 Digits)
- ★ On LH Side of Steering Tube
(Alpha-Numeric - 17 Digits)
(for applicable countries)

Engine Number Location

On LH Side Crankcase Near Gear
Change Lever (Alpha-Numeric - 11 Digits)

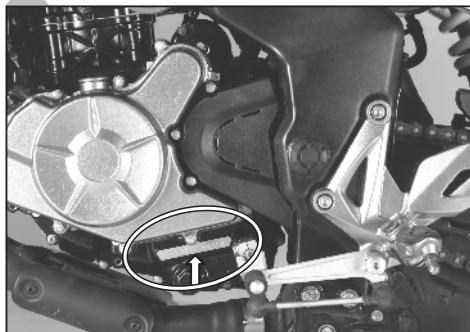

Location of Parts

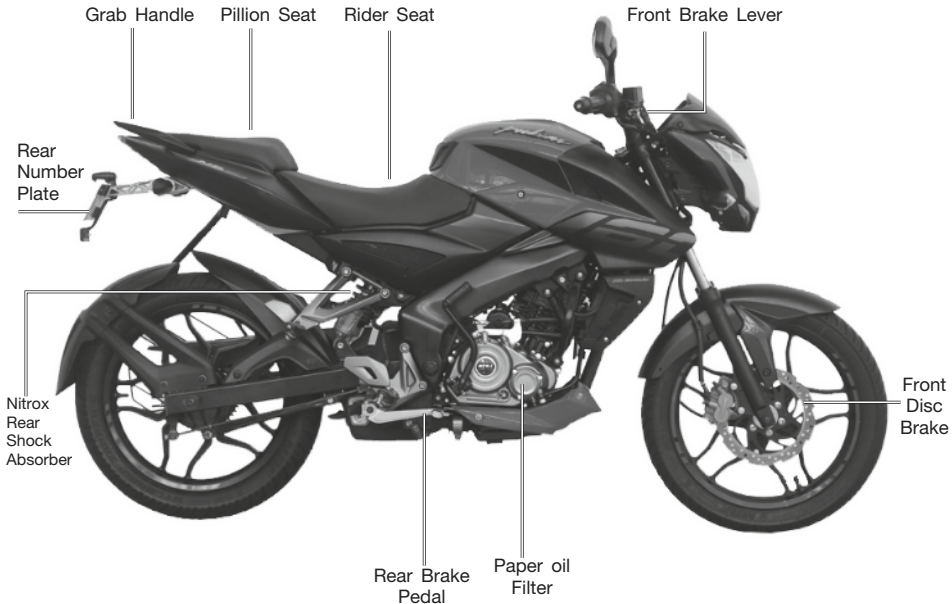

pulsar
NS160





Steering cum Ignition Lock :

It has three positions.

	LOCK: Steering locked. Ignition OFF.
	OFF: Steering unlock. Ignition OFF.
	ON: Steering unlock. Ignition ON.

To Lock the Steering : To lock the steering, turn the handle bar to the left side. Push & release the key. Turn the key to “LOCK” position and remove the key. **Steering lock can be done on left side only.**

To Unlock the Steering : To unlock steering, insert the key in steering cum ignition lock & turn it clockwise to “OFF” or “ON” position.

Key : A common key is used for ‘Steering cum Ignition lock’, ‘Fuel tank cap’ & ‘Rear Seat’.

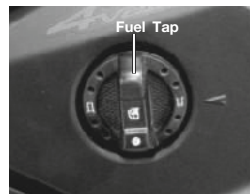
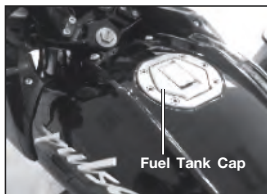

Fuel Tank Cap

- To open the fuel tank cap, open the flap. Insert the key in the lock and turn it clockwise and lift fuel tank cap.
- 'Fuel Tank Cap' gets locked when pushed back into place.

Fuel Tap

Fuel tap has following positions.

	ON : When fuel level is above Reserve position.
	RES: When fuel level is below Reserve position.
	OFF: When fuel supply is to be cut off.

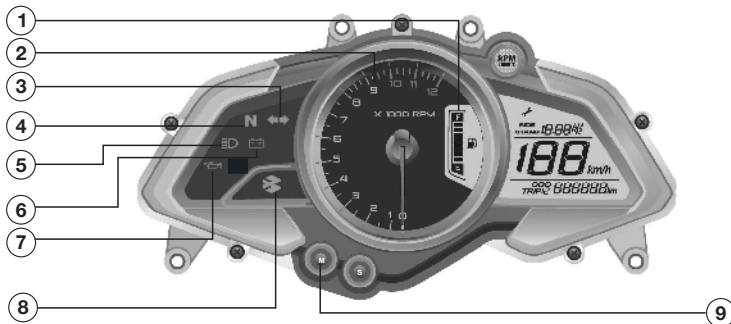

Speedometer display will work when, only both Ignition switch & kill switch are in 'ON' position.

- 1. Fuel Level Indicator:** It shows fuel level in fuel tank.
- 2. Tachometer Dial:** It shows engine speed in RPM.
- 3. Turn Signal Indicator (LH & RH):** When Turn signal switch is turned to Left or Right, Turn pilot Indicator - LH or RH will flash.
- 4. Neutral Indicator:** When the transmission is in Neutral, Neutral indicator will glow.
- 5. Hi Beam Indicator:** When Headlight is 'ON' & Hi beam is selected with engine running, Hi beam indicator will glow.

- 6. Low Battery Indicator :** It indicates battery needs charging.
- 7. Low Oil Pressure Indicator () :** It blinks when engine oil pressure is low.
- 8. Bajaj Logo :** Bajaj logo flying 'B' continuously glows.
- 9. Mode Button :** Mode button used for changing the mode while selecting & setting Trip1, Trip2, ODO, Clock & Service reminder.

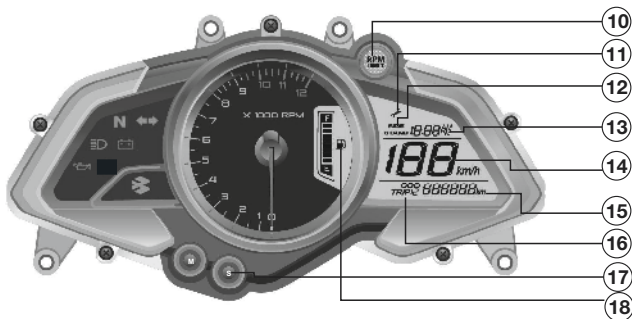

10. **Engine Over Rev Indicator** : It glows when engine RPM crosses 9500 RPM.
11. **Service Reminder** (🔧): 'Spanner' symbol glows when ODO meter reading reaches set Kms. for service. This icon will flash at -
 1st : 450 km 2nd : 4950 km,
 3rd : 9950 km, 4th : 14950 km
 and subsequently at each 5000 kms. Icon will continue to glow till it is reset. **This icon is to be reset after service is carried out.**
12. **Side Stand Indicator** : When side stand is 'ON' . Side Stand Indicator will light.
13. **Digital Clock** : It indicates **time in HR : M (AM/PM)**
14. **Speedometer**: Vehicle speed will be displayed in digital form in Km / Hr.
15. **Odometer** : The Odometer shows the total distance that the vehicle has covered. Odometer can't be reset to 'Zero'.
16. **Trip Meter** : Trip 1 & Trip 2 shows the distance traveled since it was last reset to zero.
17. **Set Button** : Set button used for setting Clock & Service reminder.
18. **Reserve Indicator** : It blinks continuously when petrol level in tank reaches reserve level (1 bar or less)



1. Trip Meter Reset :

- Mode & Set push button is provided for selecting & resetting 'ODO/TRIP1/TRIP2'. LHS part of speedo console.

1.	Press 'Mode' button for less than 2 sec.	Mode changes from 'ODO/TRIP1/TRIP2'
2.	Press 'Mode' button for more than 15 sec.	Selected mode 'TRIP1/TRIP2' will get reset. Other TRIP mode will continue updating.

2. Service Reminder Reset (wrench icon) :

- 'Wrench' symbol glows when ODO meter reading reached to set Kms.

This icon will glow at-

- 1st : 450 Kms 2nd : 4450 Kms
 3rd : 9450 Kms 4th : 14450Kms
 & subsequently at each 5000 Kms.

Note : Engine & motorcycle speed should be zero.



3. Clock Reset :

- Digital clock indicates time in HR & MM separated by colon ':'
- It is a 12 hour clock.
- Initially ':' will be blinking
- Clock setting is possible in TRIP 1 mode only.

1.	Press 'Mode' push button for less than 2 sec.	TRIP1 Mode selected
2.	Press 'Mode' & 'Set' push button together for more than 2 sec.	':' stops blinking Digits start blinking
3.	Press 'Mode' button for less than 1 sec.	Hour digits will increase by one.
4.	Press 'Set' button for less than 1 sec.	Minute digits will increase. If Mode/Set button is pressed continuously then digits will stop blinking.
5.	Press 'Mode' & 'Set' button together for more than 2 sec.	Set value will be saved Exit clock setting mode Digits stop blinking ':' start blinking
6.	Clock set 'Mode' is selected & no editing is carried out for more than 5 sec. or Vehicle is started.	Auto exit without saving set value.

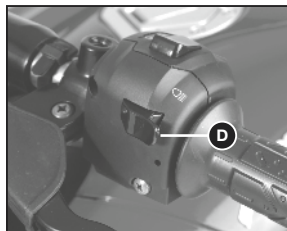
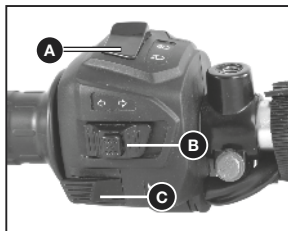

Left Handle Bar Switches

A. High/Low Switch : When headlight is ON, High or Low beam can be selected with this switch. Hi beam indicator light located on Speedo console will light up when high beam is selected.

☰ : High Beam ☷ : Low beam

B. Turn Signal Switch : When the turn signal knob is pushed to Left (↶) or Right (↷) respective indicator will start blinking, to exit push the knob in & release.

C. Horn Button : (📢) Press button for sounding horn.

D. Pass Switch : Press the switch to flash the head light. It is used to give signal to vehicles coming from opposite side while overtaking.

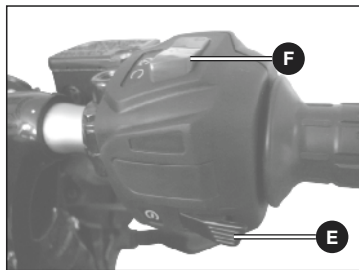

Right Handle Bar Switches

E. Starter Button :

Starter button operates the electric starter when clutch lever is depressed with transmission in any gear.

It is recommended to start the engine with the transmission in neutral.

F. Engine Kill Switch :

The engine kill switch is for emergency use. In an emergency, move the engine kill switch to the 'OFF' (⊗) position.

Speedometer display will work when both Ignition switch & kill switch are in 'ON' position.



CAUTION : While starting ensure that engine kill switch is in ON (⊙) position.

Engine will not start if the kill switch is in OFF position

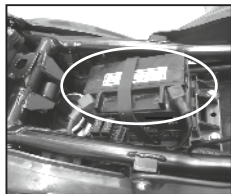
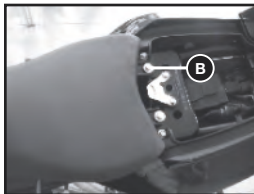
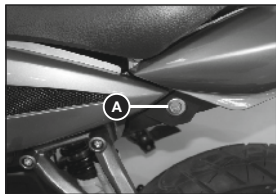

Removal of Rear Seat

- Insert Key into lock (A)
- Turn the key clock wise.
- Pull front end of 'Rear seat'
- Take out 'Rear seat'

Tool Kit Location

- It is located below the 'Rear seat'.
- 2 rubber straps are provided to hold the tool kit.

 **CAUTION** : Always ensure rubber strap is fitted for securing tool kit.

Removal of Front Seat

- First remove 'Rear seat'.
- Remove 'Front seat' mounting bolts (B).
- Pull back rear end of 'Front seat'.
- Take out 'Front seat'.

Battery

- It is located below 'Front seat'.

Battery details are given in 'Battery Maintenance'.

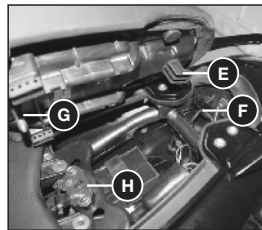
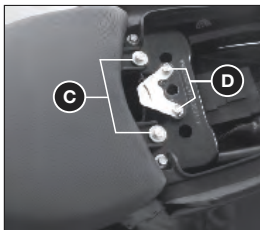
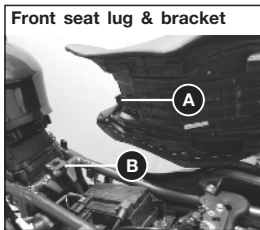

Fitment of 'Front Seat'

- Match the lugs of 'Front seat' (A) with chassis bracket (B).
- Push 'Front seat' toward petrol tank.
- Match 'Front seat' rear brackets (C) with the holes provided on chassis.
- Tighten the bolts (D).

Fitment of 'Rear Seat'

- First make sure 'Front seat' is fitted properly.
- Place 'Rear seat' in fitment location.
- Insert bracket (E) of seat into hook (F).
- Match the rod of 'Front seat' (G) with seat lock (H).
- Press front portion of seat.

Before riding motorcycle be sure to check following items. Please give proper importance to these checks and perform all of them before riding motorcycle.

If any irregularities are found during these checks, refer to the Maintenance chapter & see your dealer for the action required to return the motorcycle to a safe operating condition.

 **Warning** : Failure to perform these checks every day before you ride, may result in serious damage or severe accident.

- Enough **fuel** for planned distance of journey. No fuel leakage in fuel lines.
- **Engine oil** level (between upper and lower level mark)
- **Throttle cable** play of 2 ~ 3 mm. Smooth operation and positive return to closed position.

- **Brake Fluid** level above MIN mark provided on reservoir, applicable to disc brake vehicle.
- **Drive Chain** slack of 20 to 25 mm adequately lubricated.
- Function of all **lights & horn**
- **Clutch lever** play - 2 to 3 mm
- Check **Coolant** level between MIN and MAX mark in coolant reservoir tank.
- Smooth **steering movement** without restriction.
- **Side stand** return to its retracted position.
- Correct **inflation pressure** in both tyres
Adequate tyre tread depth - no cracks / cuts.
- Correct **rear viewing** span adjustment of mirror.

1. Starting The Engine :

- Turn the fuel tap knob to 'U' or 'H' position.
- Turn ignition switch key to 'I' position.
- Keep kill switch in 'O' position.
- Confirm that transmission is in neutral / press the clutch lever.
- If the engine is cold or when starting for first time, use manual choke (|X|) for quick starting. Choke lever is located on LH side of carburettor.
- Keep throttle completely closed, press starter button,
- Release starter button as soon as engine starts.
- When the engine is warmed up enough to idle without using choke, return the manual choke to OFF position.

Note : Do not let the engine idle longer than 3 minutes otherwise it will overheat.

 **Caution :** Do not operate the starter continuously for more than 5 seconds otherwise battery would get discharged.

Wait 15 sec. between each operation of the starter which will facilitate battery to recover.

Note : The motorcycle is equipped with a starter lockout switch. This switch ensures that engine does not start if the transmission is in gear. However, the engine can be started in any gear if the clutch lever is pressed.

Note : In case of battery discharged condition, vehicle can be started by pushing it.

2. Shifting Gears :

- Close throttle & depress the clutch.
- Shift into next higher or lower gear.
- Open the throttle and release the clutch lever slowly and simultaneously.

3. Moving Off :

- Check that side stand is up / retracted.
- Depress the clutch lever.
- Shift into 1st gear.
- Open the throttle and release the clutch lever slowly and simultaneously.
- As the clutch starts to engage, open the throttle a little more, giving the engine just enough rpm to prevent it from stalling.

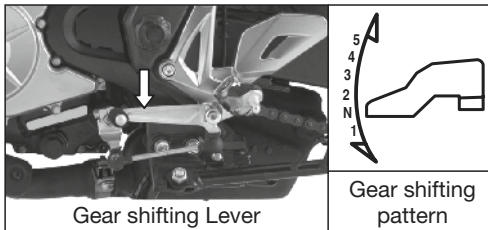

Gear shifting Lever

Gear shifting pattern

Recommended Speed for Shifting Down

From 5 th to 4 th Gear	45 km/h
From 4 th to 3 rd Gear	35 km/h
From 3 rd to 2 nd Gear	25 km/h
From 2 nd to 1 st Gear	15 km/h

Warning : When shifting down to lower gear, do not shift at such high speed that engine rpm jumps excessively. This may cause engine damage, & rear wheel may skid. Downshifting should be done at speeds as recommended in table above.

4. Braking :

- Close the throttle completely, leaving the clutch engaged (except where shifting gears) so that the engine braking will help slow down the motorcycle.
- Shift down one gear at a time so that you are in Neutral when you come to a complete stop.
- When stopping, always apply both brakes at the same time. De-clutch as necessary to avoid engine stalling.
- Never lock the brakes, or it will cause the tyres to skid. When cornering, use brakes judiciously and do not de-clutch. Reduce your speed before you get into the corner. For emergency braking, disregard downshifting, and concentrate on applying brakes as hard as possible without skidding.

5. Stopping the Vehicle :

- Close the throttle completely.
- Shift the transmission into neutral.
- Bring the vehicle to complete stop.
- Turn the ignition switch off.

6. Parking the Vehicle :

6.1 Parking using center stand.

- Support the motorcycle on a firm level surface with the center stand.

6.2 Parking using side stand.

- Support the motorcycle on a firm level surface with the side stand.
- Lock the steering.



CAUTION : Do not park on a soft or steeply inclined surface or the motorcycle may fall over.

7. Running IN

Proper running-in is important for better life & trouble free performance of the vehicle.

- During first 2000 kms running-in period do not exceed following speed limits.

Kms	1st	2nd	3rd	4th	5th
0 - 1000	14	22	30	38	44
1000 - 2000	19	30	42	52	61

- Always keep the speed below the limits mentioned in the table.
- Do not rev the engine excessively.
- Do not start moving or rev the engine immediately after starting. Run the engine for a minute at idle speed to give the oil a chance to workup into the engine.

Fuel Saving Tips :

A well maintained vehicle and good driving can contribute a lot to the saving of fuel. Following are a few simple fuel saving tips.

Good Riding Habits :

- Ride smoothly and steadily at a reasonable speed.
- Avoid harsh braking.
- Change the gear judiciously according to the speed and load requirement.
- Don't overload the vehicle above the specified payload.
- Use the accelerator judiciously.
- Cut off the engine if you want to stop for more than two minutes.

How to check mileage (Fuel efficiency)

Best way to calculate mileage is by following the full tank to full tank method.

- Fill way tank full up to small mouth (brim).
- Run the bike for say 100 km.
- Fill the tank full again in same fuel filling station, preferably from same fuel dispenser.
- Divide kilometers run / fuel quantity filled.

Ensure following maintenance points to get optimum performance from your bike.

Fuel	Check fuel lines & connections for leakage.
Spark Plugs	Inspect and clean spark plugs. Adjust electrode gap. Replace spark plugs as per P.M. Chart.
Air Filter	Clean the air filter element periodically. Replace as per Periodic Maintenance Chart.
Engine Oil	Check engine oil level. Always use recommended grade and quantity.
Brakes	Ensure that the brakes are not dragging / binding.
Clutch	Ensure correct clutch lever play.
Tyre Air Pressure	Always maintain recommended tyre pressure.
Carburettor	Clean & adjust the carburettor. Adjust idling speed.

Safe Riding Tips

- Always wear Helmet while riding. Your helmet should conform to appropriate Safety standards.
- Thoroughly read the instructions given in this manual and follow them carefully.
- Avoid unnecessary accessories for the safety of both rider and other motorists.
- Get familiar with and follow traffic rules & regulations in your states as well as general traffic signs.
- Familiarise yourself well with starting, acceleration and braking of the vehicle.
- When applying the brakes, use both front & rear brakes simultaneously. Applying only one brake may cause the rider to lose control.
- Riding at proper speed and avoiding unnecessary acceleration and braking are important not only for safety and low fuel consumption, but also for long life of the vehicle.
- During monsoon drive the vehicle more cautiously. Remember vehicles skid more easily during light showers.



- Drive cautiously. Start early & reach your destination safely.
- Always carry vehicle registration & insurance papers, and a valid driving licence with you.
- Avoid driving on loose sand or stones where vehicle is likely to skid.
- Properly wrap-up loose clothes while riding to avoid entangling in wheel or other objects on road.
- Always concentrate on Safe riding.

Rainy Season Care :

- It is suggested to customer to take appropriate care in area of high rainfall area. Appropriate surface preventive coat to avoid rusting on account of adverse atmospheric conditions.
- Vehicle cleaning to be done with soft & clean wet cloth to avoid scratches on painted parts.
- Clean & lubricate all the important parts as detailed in a periodic maintenance chart.
- Do not apply direct water jet on painted, electrical / electronic parts.
- Do not obstruct engine cooling by adding mud protection sheet from front.

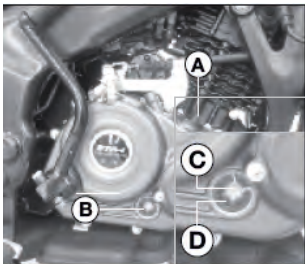

- A : Oil Filler Cap**
B : Oil Level Window

Engine Oil Level Checking :

- Check engine oil level every day in the morning. Park vehicle perpendicular to the ground on level surface as mentioned.
- Check oil level through oil level window 'B'.
- Always maintain engine oil level between upper (C) and lower (D) mark provided on Clutch cover RHS. Top up with specified grade of oil, if the oil level is below lower level mark.

Engine Oil Capacity :

- Refill at servicing : 1350 ml.(1200ml.+150 ml.)
- During engine overhaul : 1550 ml.(1400ml.+150 ml.)

Recommended Engine Oil:

Model	Recommended Engine oil Grade
Pulsar NS 160	SAE 20W50 API 'SL', or JASO 'MA'

- Engine oil replacement frequency : 1st service & then every 5,000 Km.
- Engine oil level top-up frequency : Every 2500 km.



CAUTION :

- It is most important to adhere to recommended grade & frequency of oil change for the purpose of long life of critical engine components. For details refer periodic maintenance chart.
- Do not reuse drained oil.
- Contact your Dealer for proper disposal of drained engine oil.



Front Wheel



CAUTION : Tubeless tyres are fitted in this motorcycle. The walls of the tyres in contact with the wheel rim should not be damaged in any way during fitment / removal of tyre. The tyre side walls in contact with wheel rim seals air.

Removing Front Wheel :

- Park vehicle perpendicular to the ground on level surface
- Remove speed sensor cable from case meter assembly.
- Loosen front axle nut.
- Remove front wheel assembly from fork.

Wheel Puncture :

- Visit nearest known tubeless tyre repair shop to remove puncture.
- Remove puncture by Filler or Plug method only.
- Do not use patch method to remove puncture of tubeless tyre.

Tyre Pressure :

Keep appropriate tyre pressure as mentioned below to increase life of the tyre & for better fuel consumption.

Pulsar NS 160	Front	25 PSI
	Rear (Solo)	28 PSI
	Rear (with Pillion)	32 PSI

Note : Ensure tyres fitted comply with local rules and regulations governing tyres.



Battery : 12V - 4 Ah VRLA

- Battery is located below front seat.

Battery Features :

- No topping-up is required
- Reduced self discharge, Enhances safety.
- No vent tube open to atmosphere hence no discharge of electrolyte through vent tube.

 **CAUTION** : Do not drive / run vehicle in battery disconnected condition. It may lead to damage of electrical / electronic components.

- Environment care must be taken to dispose off the used battery.

- It is always recommended to hand over the same to an Authorised battery / Bajaj dealer for proper disposal.
- When low battery icon pops-up on speedometer display, it is advised to get in touch with Bajaj dealer & get it charged immediately.

How to keep battery healthy ?

- Switch 'Off' ignition when engine is not running.
- Get battery checked/ charged during periodic services.
- Do not press starter button for more than 5 sec. After 3 successive cranking, wait for 15-20 sec. for battery to recover.
- **Do not add extra electrical accessories such as - Remote, Bigger Horn, Musical brake light etc. This will reduce life of battery**
- Disconnect battery +ve & -ve wires if vehicle is to be stored for more than 2 weeks. This avoids self discharge.

Spark Plug

- Remove spark plugs by using plug spanner.
- Clean the spark plugs.
- Adjust the gaps if incorrect by bending outer electrode carefully.

Spark Plug Gap : 0.7 to 0.8 mm.

Spark Plug (2 Nos.) : BOSCH UR4AC
Champion PRZ9HC

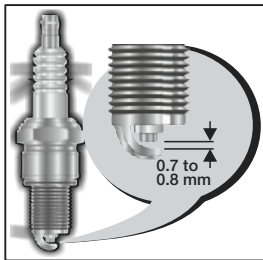

Drive Chain Slackness

- Chain slackness will have to be adjusted whenever required.
- Std. Chain slackness 20 ~ 25 mm.
- Marking on chain adjusters should be identically positioned on both sides.



Drive
Chain
Cleaning

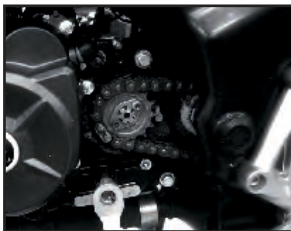

Drive
Chain
Lubrication

Drive chain must be cleaned & lubricated as per periodic maintenance schedule.

Drive Chain (O-ring type)

- 'O' rings must always be kept wet for best performance hence lubricate every 500 Km.
- **O-ring chain lubrication can easily be done by owners using Bajaj 'Chain Lube Spray Can' available with Bajaj dealers, or equivalent. Ensure that the lubricant does not damage the rubber 'O' rings.**

Method of O-ring Chain Lubrication :

- Park vehicle perpendicular to the ground on level surface as mentioned. Clean the chain by using lint free cloth (If excessive mud / slush found approach Bajaj Service Center for proper cleaning)
- Shake the can vigorously by holding vertically upright till the noise of steel ball inside heard uniformly.
- Hold spray can at the back of rear sprocket with extension tube nose at 5~10 cm.
- Rotate the wheel in reverse direction & spray the lube on middle portion of the chain up to full length of the chain.

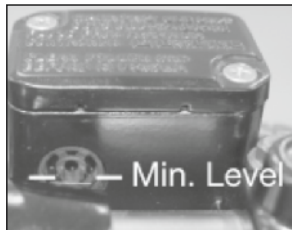

Front Brake Fluid Reservoir

Front & Rear Brake Fluid Level

- Front brake fluid reservoir is located on RH side of Handle bar.
- Rear brake fluid reservoir is located behind RH pillion holder bracket.
- To check oil level, Park vehicle perpendicular to the ground on level surface as mentioned with handle bar in straight ahead condition
- Always ensure that brake fluid level is above 'MIN' mark given on inspection Window.

Brake Fluid Replacement

- Check & Adjust brake fluid level in every service.
- Change the brake fluid of the front & rear brake according to service schedule.

Use only DOT-3 or DOT-4 brake fluid (from sealed container) for top up & replacement.

Periodic Maintenance & Lubrication Chart



Sr. No.	Operation	Servicing	RECOMMENDED FREQUENCY							Remarks
			1st	2nd	3rd	4th	5th	6th	7th	
			Kms	500 750	4500 5000	9500 10000	14500 15000	19500 20000	24500 25000	
1	Clean the vehicle with water wash & dry completely		✓	✓	✓	✓	✓	✓	✓	Ensure to prevent water entry in Petrol tank, Silencer & electrical parts. Use caustic free detergent for washing.
2	Engine oil & engine oil filter*	C,R	R	R	R	R	R	R	R	SAE 20W50 "API SJ" Grade Replace at every 5000kms. And top-up at every 2500 Kms (If required)..
3	Oil strainer	CL	CL		CL		CL		CL	Oil strainer cleaning at the time of oil change.
4	Spark plug	CL,A,R			CL,A		CL,A		R	
5	Air cleaner element & cover 'O' ring	CL,R				R			R	
6	In line Paper filter or fuel cock paper filter	R				R			R	
7	Fuel cock sediment bowl cleaning	CL				CL			CL	
8	Carburetor rubber duct	C,R					C,R			Check & replace if required
9	Fuel Pipe	C,R				R			R	
10	Valve tappet clearance	C,A				C,A			C,A	

Periodic Maintenance & Lubrication Chart



Sr. No.	Operation	Servicing	RECOMMENDED FREQUENCY							Remarks
			1st	2nd	3rd	4th	5th	6th	7th	
			Kms	500 750	4500 5000	9500 10000	14500 15000	19500 20000	24500 25000	
11	Sealed Drive chain cleaning & lubrication	CL,L,A	CL,L A	CL,L A	CL,L A	CL,L A	CL,L A	CL,L A	CL,L A	Customer to apply OKS chain lube spray @ every 500 kms
12	Engine Air Breather Tube	C,R				C,R			C,R	Check & replace if required
13	Brake cam & brake pedal pivot pin	C,L,R	C	C,L,R	C,L,R	C,L,R	C,L,R	C,L,R	C,L,R	Use recommended AP grease.
14	Brake lining or pad -Check wear indicator	C,R	C,R	C,R	C,R	R	C,R	C,R	R	Replace brake shoes /brake pad at every15000 Kms
15	Brake fluid level** - top up / replace	C,A,R				C,A			R	Use recommended brake fluid (DOT3/DOT4).
16	Disc brake assly -- Check functionality, leakage or any other damage.	C			C		C		C	Replace if damaged
17	All cables & rear brake pedal -free play	C,A	C,A	C,A	C,A	C,A	C,A	C,A	C,A	
18	Wiring harness & Battery connections- routing, tie bands & clamps tightness.	C,A,T	C,A,T	C,A,T	C,A,T	C,A,T	C,A,T	C,A,T	C,A,T	
19	Steering play	C,A	C,A	C,A	C,A	C,A	C,A	C,A	C,A	
20	Ignition switch barrel cleaning & handle bar control switches contacts cleaning,	C,CL	C,CL	C,CL	C,CL	C,CL	C,CL	C,CL	C,CL	Use recommended WD40 spray

Periodic Maintenance & Lubrication Chart



Sr. No.	Operation	Servicing	RECOMMENDED FREQUENCY							Remarks
			1st	2nd	3rd	4th	5th	6th	7th	
			Kms	500 750	4500 5000	9500 10000	14500 15000	19500 20000	24500 25000	
21	Steering stem bearing*** & Cap steering bearing(Plastic)**	C,CL L,R	C,CL L,R	C,CL L,R	C,CL L,R	C,CL L,R	C,CL L,R	C,CL L,R	C,CL L,R	Check & replace if damaged. Use HP Lithon RR3 grease for lubrication.
22	Main Stand & Side stand pin	CL,L			CL,L		CL,L		CL,L	Use recommended AP grease.
23	All fasteners tightness	C,T	C,T	C,T	C,T	C,T	C,T	C,T	C,T	
24	Engine Foundation silent bushes**	C				C			C	
25	General lubrication-Clutch lever, front brake lever, kick lever.	L	L	L	L	L	L	L	L	Use recommended AP grease.
26	Ideal Speed / CO %	C,A	C,A	C,A	C,A	C,A	C,A	C,A	C,A	
27	SAI system Hoses-Check functionality, leakage or any other damage.	C,R			C		C		C	Replace if cut / damaged
28	EVAP Y connector drain tube cleaning**	C,L	C,L	C,L	C,L	C,L	C,L	C,L	C,L	Applicable for product with EVAP system only

* It is strongly recommended to use only recommended grade of oil.

** As applicable to model .

*** More frequent cleaning is required while driving in dusty environment.

C : Check, A : Adjust, CL : Clean, R : Replace, T : Tighten, L : Lubricate

Note: periodic parts / lubricants as per periodic maintenance & chart are mandatory & the same is chargeable to customer.

Non-use maintenance is necessary if a vehicle remains off road for a longer duration (more than 15 days**). The correct and careful non-use maintenance carried out before storing the vehicle will prevent the vehicle from rusting and from such other non-operational damages like fire hazards.

- Clean the entire vehicle thoroughly.
- Empty the fuel from the fuel tank and carburettor float bowl (if fuel is left in for a longer time, the fuel will break and gummy substance could clog the carburettor).
- Remove spark plug & put several drops of engine oil into the cylinder. Kick engine over slowly a few times to coat cylinder wall with oil & install spark plug.
- Set the vehicle on a box or a stand so that both wheels are raised off the ground.
- Spray oil on all unpainted metal surfaces to prevent rusting. Avoid getting oil on rubber parts or brake liners.
- Cover entire vehicle neatly. Make sure that storage area is well ventilated & free from any source of flames or spark.
- Fill 10% excess air pressure in both wheels.
- Do not apply oil on front brake disc, to prevent rusting. If the front brake disc rusts during storage, do not attempt to clean it with soap water. The rust will go off automatically during first few application of brake.

**** For Battery :**

- a. Remove battery and keep it on wooden plank, in properly ventilated area.
- b. Before taking the vehicle for use.
 - Get the battery recharged from the Authorised Service Center / Battery Dealer.
 - Apply petroleum jelly on terminals. (applicable to certain models).

Preparation for regular use after storage :

- Clean the vehicle
- Fit the battery after recharging.
- Make sure the spark plug is tight.
- Fill the fuel tank with fuel.
- Change the engine oil.
- Check all the points listed in the Daily Safety Checks section.
- Check and inflate tyres to proper tyre pressure.
- Fill 10% excess air pressure in both wheels.
- Do not apply oil on front brake disc, to prevent rusting. If the front brake disc rusts during storage, do not attempt to clean it with soap water. The rust will go off automatically during first few application of brake.

**** For Battery :**

- a. Remove battery and keep it on wooden plank, in properly ventilated area.
- b. Before taking the vehicle for use.
 - Get the battery recharged from the Authorised Service Center / Battery Dealer.
 - Apply petroleum jelly on terminals. (applicable to certain models).

Preparation for regular use after storage :

- Clean the vehicle
- Fit the battery after recharging.
- Make sure the spark plug is tight.
- Fill the fuel tank with fuel.
- Change the engine oil.
- Check all the points listed in the Daily Safety Checks section.
- Check and inflate tyres to proper tyre pressure.

